



TA6000 Series

All In One Energy Storage System



User Manual

LEGAL NOTICES

The copyright of this product belongs to Shenzhen Littech Energy Co., Ltd. Without the written permission of the copyright party, no unit or individual may extract, reproduce or translate in any way.

Infringement must be investigated.

This product complies with the design requirements for environmental protection and personal safety. The storage, use and disposal of the product should be in accordance with the requirements of the product manual, relevant contract or corresponding national laws and regulations.

When there is a product update or a technical change, you can inquire related information through the technical support website of Shenzhen Littech Energy Co., Ltd.

Website: <http://www.ltc-energy.com/>

If this product is improved or technically changed without notice.

VERSION	DATE	CONTENT
1.0	2025.01.20	Initial Release

PRECAUTIONS

Warning

1. It is strictly forbidden to place the battery in water or fire, so as to avoid explosion or other dangers, endangering personal safety.
2. Please connect the cables properly during installation, do not reverse the positive and negative poles; do not directly connect the positive and negative poles of the battery with a conductor (such as a wire) to avoid short-circuiting the battery.
3. Do not strike the battery with a needle, hit it with a hammer, step on it hard, or otherwise.
4. During use, when the system needs to be moved or rewired, the power must be completely cut off and the system must be completely shut down, otherwise there will be danger of electric shock.
5. In case of fire, please use dry powder fire extinguisher to extinguish the fire. Using liquid fire extinguisher may cause secondary danger.
6. Under no circumstances, please do not disassemble any part of the system without our company or technical personnel authorized by our company, in order to prevent danger or injury to your personal safety, and the equipment failure caused by this is not covered by the warranty.

Remind

1. The product has been strictly inspected before shipment. If you find that the purchased product has abnormal phenomena such as obvious deformation and odor, please contact us in time.
2. In order to ensure the normal use and safety of the product, the equipment must be reliably grounded before use.
3. In order not to affect the normal use, please ensure that the electrical parameters of the related equipment are compatible and compatible with each other before use.
4. Do not mix batteries from different manufacturers, different types, different models, and old and new batteries.
5. The use environment and storage methods have a certain impact on the service life and reliability of this product, so environmental factors must be fully considered before installation and use to ensure that the system is used in a suitable environment.
6. For long-term storage, the battery needs to be recharged once every 6 months, and the recharged power should exceed the rated capacity by 80%.
7. After the battery is discharged to over-discharge protection, it should be recharged within 24 hours. The theoretical battery discharge time is: $T=C/I$ (T is the discharge time, C is the battery capacity, and I is the total load current.)

Foreword

Manual Description

TA6000 Series lithium iron phosphate battery storage system can provide power storage function for photovoltaic power generation users through parallel combination. During the day, the excess power of solar energy can be stored in the battery, and at night or when needed, the stored energy is used to power electrical equipment, which can improve the efficiency of solar energy, peak shaving, and emergency power backup.

This user manual system introduces the basic structure, parameters, installation, operation and maintenance of the equipment in detail.

Contents

1. INTRODUCTION	4
1.1 Introduction	4
1.2 Product Features	4
1.3 Product Identification Definition	4
2. SPECIFICATIONS	5
2.1 Size & weight	5
2.2 Performance parameter	5
2.3 Interface Definition	6
2.3.1 Definition and description of DIP switch	7
2.3.2 Indicator definition and description	8
2.3.3 Buzzer action description	8
2.3.4 Button description	9
2.3.5 Sleep and wake	10
2.3.5.1 Sleep	10
2.3.5.2 Wake	10
2.3.6 RS232 communication	10
2.3.7 RS485 communication	11
2.4 Battery Management System (BMS)	11
2.4.1 Low Voltage Protection	11
2.4.2 Other Protection	11
2.4.3 Temperature Protection	12
2.4.4 Other Protection	12
3. INSTALLATION AND CONFIGURATION	12
3.1 Installation&Prepration	12
3.1.1 Environment Requirement	12
3.1.2 Tools	13
3.1.3 Unpacking inspection	13
3.1.4 Unpacking inspection	14
3.1.5 Engineering coordination	15
3.2 Equipment installation	15
3.2.1 Preparation for installation	16
3.2.2 Mechanical installation	16
3.2.3 Electrical installation	17
4. USING	18
4.1 Maintenance and troubleshooting	18
4.2 Alarm Description and Solution	19
4.3 Analysis and solution of common faults	20

1. Introduction

1.1 Introduction







The TA6000 Series lithium iron phosphate battery system is a standard battery system unit. Customers can choose a certain quantity of TA6000 according to their needs, and form a larger capacity battery pack in parallel to meet users' long-term power supply needs. The product is especially suitable for applications with high operating temperature, limited installation space and long service life.

1.2 Product Features

The TA6000 Series uses lithium iron phosphate as the battery anode material and is equipped with a high-performance BMS to effectively manage the battery cells. The system has the following characteristics:

- Meet European ROHS regulations, pass CE certification, use the best non-toxic and pollution-free battery;
- The battery anode is made of lithium iron phosphate (LiFePO₄) material, which has good safety performance and long cycle life;
- Adopt high-performance BMS battery management mode, with over-discharge, over-charge, over-current, temperature and other protection functions;
- With charge and discharge automatic management and single cell balance function;
- Fully intelligent design, equipped with a centralized monitoring module, with three remote (telemetry, remote signaling and remote control) functions;
- Flexible configuration, multiple system units connected in parallel can extend the power supply time of the system;
- Self-cooling method, the whole system has extremely low noise;
- The battery has less self-discharge, and it can be recharged for up to 10 months during storage; no memory effect, shallow charging and discharging;
- Wide temperature working range, -20 °C ~ + 60 °C, good cycle life and discharge performance at normal temperature;
- Small battery size and light weight.

1.3 Product Identification Definition

 Voltage of battery is higher than safety voltage, it's dangerous to touch.	 Read manual before operation.	 Please recycle the battery after serving.
 Operate carefully.	 Default battery can't be thrown to trash can.	 CE standards are met.

2. Specifications



Model	TA6000-M2	TA6000-M3	TA6000-M4
Nominal Voltage		51.2V	
Nominal Capacity	200Ah	300Ah	400Ah
Max Charge & Discharge Current	200A	300A	400A
Energy	10.24kWh	15.36kWh	20.48kWh
Chemistry	LiFePO ₄		
Cycle life	5000 times 80% SOH (8000 Cycles 60% SOH)		
Rated Output Power	8~10kW(Optional)	8~12kW(Optional)	8~12kW(Optional)
Rated Output Voltage	120V(US) / 230V(EU)		
PV Input Power	11kW	11~13.2kW	11~13.2kW
MPPT efficiency	99.9%		
Grid frequency range	50 Hz/60 Hz		
Certification	CE / UN38.3 / MSDS / UL9540(on going)		
Communication	RS485, Ethernet, CAN		
Operating Temperature	-20°C to 60°C		
Dimensions(L×W×H)	W590mm*D570mm*H1880mm		
Weight	~244kg	~286kg	~328kg

2.1 Interface Definition

TB4000X Product panel interface configuration and functions. This section details the functions of each interface on the front panel of the device.

Fig. 2-3 Interface diagram

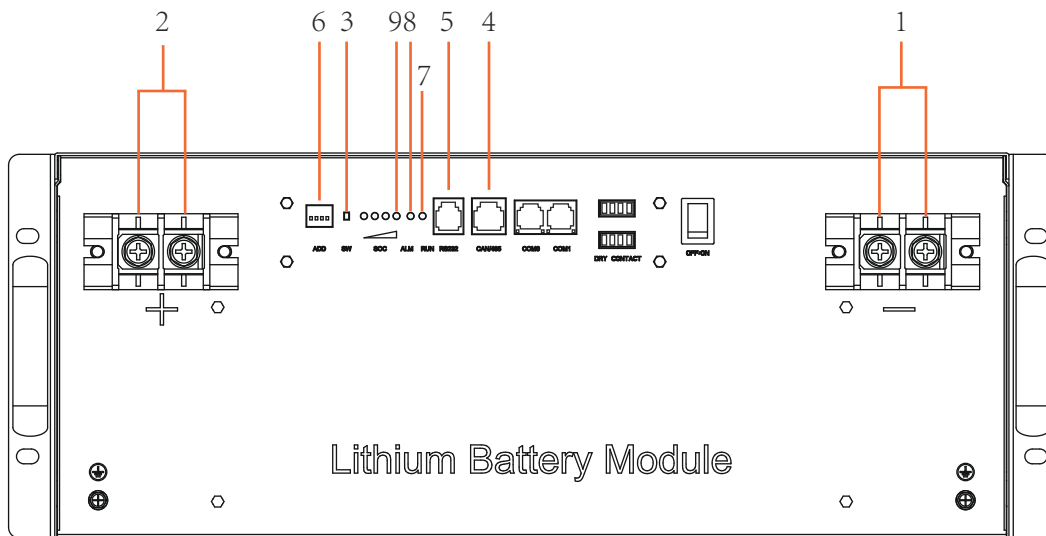

Item	Name	Definition
1	Negative socket	Battery output negative or parallel negative cable.
2	Positive socket	Battery output positive or parallel positive cable.
3	SW (Wake on battery / Sleep switch)	When the "OFF / ON" key is ON, press and hold this key for 3 seconds. Put the battery into the power-on or hibernation state.
4	RS485	Slave internal parallel communication port, support RS485 communication.
5	RS232	Debug communication port, support RS232 communication.
6	ADD	DIP switch.
7	RUN	Green light, flashing during standby, flashing during charging, and always on when discharging.
8	ALM	Red light, flashing when atm. Protection is always on. Conditions that trigger protection. Normally recover automatically after lifting.
9	SOC	The number of green lights shows the remaining battery power, as shown in Table 2-3.

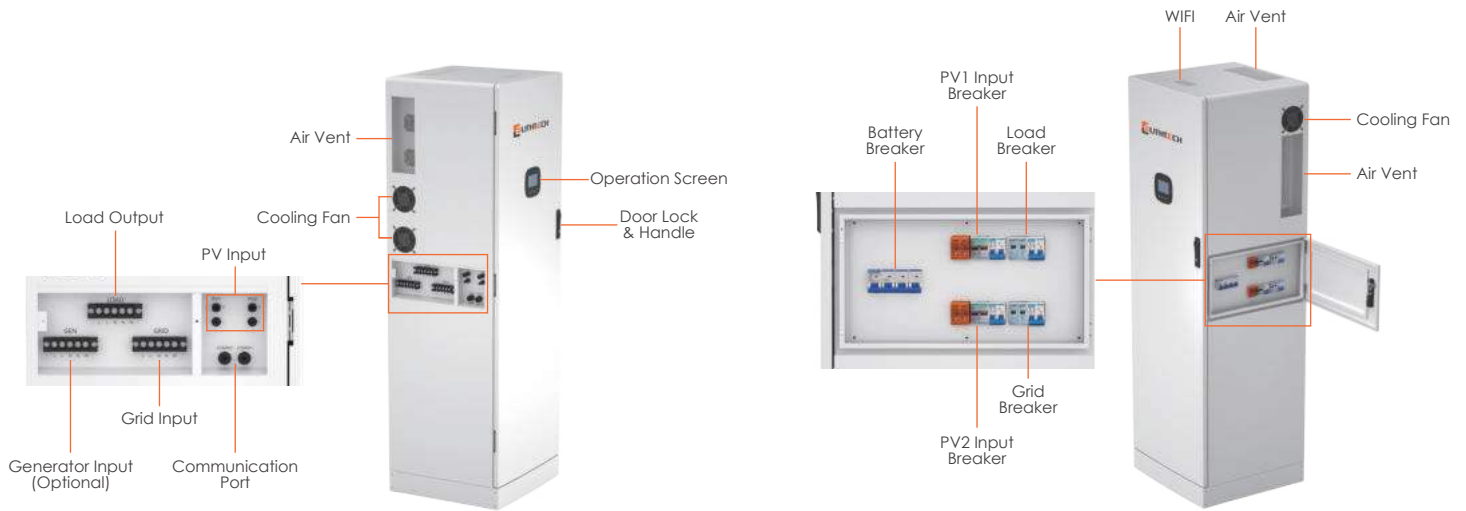

Item	Name	Definition
1	Operation Screen	Checking or setting battery & inverter information.
2	Door Lock & Handle	Lock the door or open the door
3	Air Vent	Cooling the inverter & battery
4	Cooling Fran	Cooling the inverter & battery
5	PV Input	Connect to PV panel
6	Load Output	Connect to home loading
7	Grid Input	Connect to Grid
8	Generator Input(Optional)	Connect to Generator
9	Communication Port	Connect to another TA6000 product for parallel connection
10	WIFI	WIFI antenna window
11	PV1 Input Breaker	PV1 over current protection
12	PV2 Input Breaker	PV1 over current protection
13	Battery Breaker	Battery over current protection
14	Load Breaker	Home loading over current protection
15	Grid Breaker	Grid input over current protection

2.2 Definition and description of DIP switch

When PACK is used in parallel, you can use the DIP switch on the BMS to set the address to distinguish different PACKS. Avoid setting the same address. The definition of the BMS DIP switch is shown in the table below.

Table 2-3: Dip switch dial definition

Address	DIP switch position				Description
	#1	#2	#3	#4	
0	OFF	OFF	OFF	OFF	Set to Pack 0
1	ON	OFF	OFF	OFF	Set to Pack 1 (host)
2	OFF	ON	OFF	OFF	Set to Pack 2
3	ON	ON	OFF	OFF	Set to Pack 3
4	OFF	OFF	ON	OFF	Set to Pack 4
5	ON	OFF	ON	OFF	Set to Pack 5
6	OFF	ON	ON	OFF	Set to Pack 6
7	ON	ON	ON	OFF	Set to Pack 7
8	OFF	OFF	OFF	ON	Set to Pack 8
9	ON	OFF	OFF	ON	Set to Pack 9
10	OFF	ON	OFF	ON	Set to Pack 10
11	ON	ON	OFF	ON	Set to Pack 11
12	OFF	OFF	ON	ON	Set to Pack 12
13	ON	OFF	ON	ON	Set to Pack 13
14	OFF	ON	ON	ON	Set to Pack 14
15	ON	ON	ON	ON	Set to Pack 15

2.2.1 Indicator definition and description

Table 2-4: LED working status indication

Status	Normal/ Alarm/ Protection	RUN	ALM	Battery indicator LED				Description
		●	●	●	●	●	●	
Shutdown	Dormant	OFF	OFF	OFF	OFF	OFF	OFF	All off
Standby	Normal	F1	OFF	According to battery indicator				stand by mode
	Alert	F1	F3					Module low voltage
Charge	Normal	ON	OFF	According to battery indicator (Battery indicator flashes up to 2 LEDs)				Highest power LED blinks (blink 2), ALM does not blink during overcharge alarm
	Alert	ON	ON					
	Over charge protection	ON	OFF	ON	ON	ON	ON	If there is no utility power, the indicator light. Go to standby.
	Temperature, overcurrent, Fail-safe	OFF	ON	OFF	OFF	OFF	OFF	Stop charging
Discharge	Normal	F3	OFF	According to battery indicator				-
	Aler	F3	F3					-
	Under voltage protection	OFF	OFF	OFF	OFF	OFF	OFF	Stop discharging
	Temperature, over current, short circuit, reverse connection, fail-safe	OFF	ON	OFF	OFF	OFF	OFF	Stop discharging
Lapse	-	OFF	ON	OFF	OFF	OFF	OFF	Stop charging & discharging

Remarks: Flash 1 is short for F1; Flash 2 is short for F2; Flash 3 is short for F3.

Table 2-5: Capacity instructions

Status		Charging						Discharging					
stand by mode		RUN ●	ALM ●	L4 ●	L3 ●	L2 ●	L1 ●	RUN ●	ALM ●	L4 ●	L3 ●	L2 ●	L1 ●
Battery (%)	SOC ≤ 0%	ON	F3	OFF	OFF	OFF	OFF	OFF	OFF	OFF	OFF	OFF	OFF
	0 < SOC ≤ 25%	ON	OFF	OFF	OFF	OFF	F2	F3	OFF	OFF	OFF	OFF	ON
	25 < SOC ≤ 50%	ON	OFF	OFF	OFF	F2	ON	F3	OFF	OFF	OFF	ON	ON
	50 < SOC ≤ 75%	ON	OFF	OFF	F2	ON	ON	F3	OFF	OFF	ON	ON	ON
	75 < SOC < 100%	ON	OFF	F2	ON	ON	ON	F3	OFF	ON	ON	ON	ON
	SOC ≥ 100%	ON	OFF	ON	ON	ON	ON	F3	F3	ON	ON	ON	ON
● Running lights		ON						F3					

Remarks: Flash 1 is short for F1; Flash 2 is short for F2; Flash 3 is short for F3.

Table 2-6: Flash description

Flashing way	ON	OFF	Remarks
Flashing 1	0.25S	3.75S	F1
Flashing 2	0.5S	0.5S	F2
Flashing 3	0.5S	1.5S	F3

Remarks: Flash 1 is short for F1; Flash 2 is short for F2; Flash 3 is short for F3.

2.2.2 Buzzer action description

When the fault occurs, every 1S will beep 0.25S;

When protecting, every 2S will beep 0.25S (except for overvoltage protection);

When the alarm occurs, every 3S will beep 0.25S (except for overvoltage alarm);

The buzzer function can be enabled or disabled by the host computer. The factory default is disabled.

2.2.3 Button description

When the BMS is in the dormant state, press the button (3~6S) and release it, the protection board is activated, and the LED indicator lights up sequentially for 0.5 seconds from "RUN". When the BMS is in the activated state, press the button (3~6S) and release it, the protection board will be dormant, and the LED indicator will turn on for 0.5 seconds starting from the lowest battery. When BMS is activated, press the button (6~10S) and release, the protection board is reset, and the LED lights are all the same Lights for 1.5 seconds.

After the BMS is reset, the parameters and functions set by the host computer are still retained. If the original parameters need to be restored, they can be implemented by the "Restore default values" of the host computer, but the related operation records and stored data remain unchanged (such as power, cycle times, Protect records, etc.)

2.3 Sleep and wake

2.3.1 Sleep

When any of the following conditions are met, the system enters the low-power mode:

- (1) Single or overall over-discharge protection has not been released within 60 seconds.
- (2) Press the button (3~6S), and release the button.
- (3) The minimum cell voltage is lower than the sleep voltage, and the duration reaches the sleep delay time (at the same time, no communication, no protection, no balance, no current).
- (4) Standby time exceeds 24 hours (no communication, no charge and discharge, no mains).
- (5) Force shutdown by PC software.

Before entering hibernation, make sure that the input terminal is not connected to external voltage, otherwise it will not be able to enter the low power consumption mode.

2.3.2 Wake

When the system is in the low power consumption mode and meets any of the following conditions, the system will exit the low power consumption mode and enter the normal operation mode:

- Connect the charger. The output voltage of the charger must be greater than 51.2V.
- Press the button (3~6S), and release the button.

Before entering hibernation, make sure that the input terminal is not connected to external voltage, otherwise it will not be able to enter the low power consumption mode.

Note: After single or overall, over- discharge protection, it enters low power consumption mode, and wakes up at regular intervals every 4 hours to turn on charge and discharge mode. Can be charged, it will exit hibernation and enter normal charging; if it cannot be charged after 10 consecutive automatic wake up, it will no longer to wake up.

When the system is defined as the end of charging, the recovery voltage is not reached after 2 days of standby (standby time set value), and the charging is forcibly resumed until the end of recharging.

2.3.3 RS232 communication

The BMS can communicate with the host computer through the RS232 interface, so that it can monitor various battery information, including battery voltage, current, temperature, status, and battery production information. The default baud rate is 9600bps.

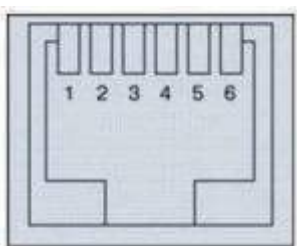
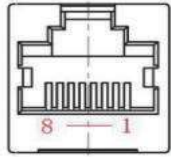

Table 2-7 RS232 interface definition

RS232—using 6P4C vertical RJ11 Socket		
RJ12 pin	Definition Description	Note
1	NC	
2	GND	
3	TXD	
4	RXD	
5	GND	
6	NC	

2.3.4 RS485/CAN communication

With dual RS485 interface, you can check the information of PACK. The default baud rate is 9600bps. If you need to communicate with the monitoring equipment through RS485, the monitoring equipment acts as the host and polls data according to the address. The address setting.



The CAN and RS485 communication port is the communication interface between the battery and external device. CAN communication has a default communication rate of 500K, and the corresponding pin definitions for the interfaces are shown in the attached figure.

RS485--using 8P8C vertical RJ45 socket		
RJ45 pin	Definition Description	Note
1、 8	RS485-B	
2、 7	RS485-A	
3、 6	GND	
4	CANH	
5	CANL	

2.4 Battery Management System (BMS)

2.4.1 Low Voltage Protection

Discharge low voltage protection:

When discharging, the voltage of any single cell is lower than the protection value, the over discharge protection will be started, the battery buzzer alarm. When the voltage of all cells is recovered to the range of released value, the protection is removed.

Charging Over Voltage Protection:

During charging, when the total voltage of battery pack or the voltage of any single cell reaches the protection value, the system stops charging. When the total voltage and the single voltage return to the released value range, the protection will be released.

2.4.2 Current Protection

Charging Over Current Protection:

When the charging current is more than the protection value, the battery buzzer will alarm and the system will stop charging. The protection will release after the system delays the rated time.



Discharging Over Current Protection:

When the discharge current is more than the protection value, the battery buzzer will alarm and the system will stop discharging. The protection will release after the system delays the rated time.

Note: The buzzer alarm setting can be manually closed on the computer, and it is off by default.

2.4.3 Temperature Protection

Charge low/high temperature protection:

During charging, when the battery temperature exceeds the range of 0°C~+60°C, the system starts the charging temperature protection, stops charging, recovering to the rated return value, and then the protection is released.

Discharge low/high temperature protection:

During charging, when the battery temperature exceeds the range of -20°C~+60°C, the system starts the charging temperature protection, stops charging, recovering to the rated return value, and then the protection is released.

2.4.4 Other Protection

Short circuit protection:

When the battery system detects any external short circuit, the BMS short circuit protection will be triggered



Release of Short Circuit Protection

When any of below conditions achieved, the protection will be released:

- (1) When charging starts;
- (2) When load has been removed..

Note: The max. discharge current of battery should be bigger than max. working current required for load.

3. Installation and configuration

3.1 Installation&Preparation

Safety Regulation

Only the personnel who have received the electrical system training and fully mastered the electrical knowledge can install this system. Always follow the safety regulations listed below and local safety regulations during installation.

- All circuits with external voltage less than 48V connected to the power system must meet SELV requirements defined in IEC60950.
- If operating inside the cabinet, make sure that the power system is not active. The battery shall also be shut down.
- The cables shall be arranged reasonably and protected to avoid touching these cables when operating the power equipment.
- It is recommended to wear the following safety gear when dealing with the battery pack.



Insulated glove



Safety shoes



Safety goggles

3.1.1 Environment Requirement

Working Temperature: -20°C ~ +60°C
 Storage Temperature: -10°C ~ +35°C
 Relative Humidity: 5% ~ 85%RH

Altitude: <4000m

Working environment: there is no conductive dust and corrosive gas, and the following conditions are met:

- The installation site shall be far away from the sea to avoid salt water and high humidity environment.
- The ground is flat and level.
- There are no inflammables and explosives in the accessories of the installation point.
- The ideal ambient temperature is 15°C ~ 30°C.
- Keep away from dust and dirty areas.

3.1.2 Tools

The tools and meters that may be used in Table 3- 1:
 Table 3-1 Tools

Name	
Screwdriver/Slotted screwdriver /Phillips screwdriver	multimeter
Torque wrench	Clamp meter
Diagonal pliers	Insulation tape
Needle-nose pliers	thermometer
Wire cutter	Anti-static bracelet
Wire stripping pliers	Tie
Electric drill	Tape measure

3.1.3 Technical preparations

Electrical interface check

Devices connected directly to the battery can be user equipment, power supplies, or other power devices.

- Confirming whether the user's photovoltaic power generation equipment, power supply or other power supply equipment has a direct current output interface, and measuring whether the output voltage of the direct current interface meets the voltage range requirements in 2.2 performance parameter table.
- Confirming that the maximum discharge current capacity of the DC interface of the user's photovoltaic power generation equipment, power supply or other power equipment should be greater than the maximum charging current of the product used in the performance parameter table. For the maximum charging current of the product used, the DC interface of the user's photovoltaic power generation equipment should have a current limiting function to ensure the normal operation of the user equipment first.
- Make sure that the maximum operating current of the battery-powered user equipment (inverter DC input) should be less than 2.2 The maximum discharge current of the product used in the performance parameter table.

Security check







It is strictly prohibited to place flammable, explosive and other dangerous materials next to the battery. Fire equipment should be available near the equipment, such as portable dry powder fire extinguishers. Where necessary, an automatic fire protection system should be provided.

3.1.4 Unpacking inspection

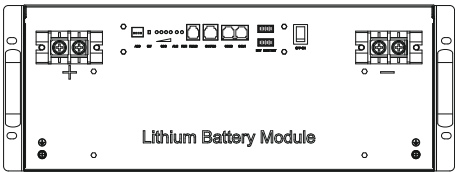
- When the equipment arrives at the installation site, it must be loaded and unloaded in accordance with regulations to prevent sunlight and rain. Before unpacking, check the total number of pieces according to the shipping list attached to each packing box, and check whether the appearance of the packing box is intact;

Manual for Energy Storage

- Handle with care during unpacking to protect the surface coating of objects;
- When opening the packaging box, the installer should first read the technical documents and check the list, and check whether the items are complete and intact according to the configuration table and packing list. If the internal packaging is damaged, it must be checked and recorded. The packing list is as follows:

Part Name	Specification	Quantity	Picture
Battery module	51.2V/100Ah	n (2,3,4)	
Slave parallel Communication line	2P: Black / 300mm / Double RJ45 plug	1	
Positive parallel line (Optional)	Red /25mm ² /L250mm	1	
Negative parallel line (Optional)	Black /25mm ² /L250mm	1	
Positive power line (Optional)	Red /25mm ² /customized	1	
Negative power line (Optional)	Black /25mm ² /customized	1	
Host and inverter Communication line (Optional)	Black/L1500mm / Double RJ11 plug	1	

3.1.5 Engineering coordination

Note the following before construction:

- **Power cord specifications**
Power cord specifications should meet the maximum discharge current requirements of each product.
- **Installation space and load**
Ensure that the battery has sufficient installation space, and that the case and bracket where the battery is installed have sufficient load-bearing capacity.
- **wiring**
Make sure the power wires are routed properly. Not easy to short circuit, water and corrosion.

3.2 Equipment installation

Table 3-2 Installation steps

Step1	Preparation for installation	1. Make sure the LEDs on the chassis are "off" to ensure no power.
Step2	Mechanical installation	1. Determine the location of the cabinet.
		2. Top harness pre-installed.
		3. Battery module installation.
Step3	Mechanical installation	1. Battery module parallel cable installation.
		2. Battery Module Header Cable Installation.
		3. Battery module total negative cable installation.
		4. Communication interface connection.
Step4	Battery system self-test	1. Press the SW key for 3 seconds.
		2. BMS system power-up activation.
		3. Check system output voltage.
		4. Shut down the system.
Step5	Connect the inverter	1. Install battery system total positive and negative cables to the inverter.
		2. Connect the external 485/CAN communication

3.2.1 Preparation for installation

- **Equipment and tools ready for installation.**

Check the case to ensure that the LED light is in the "off" state to ensure no-power operation.

3.2.2 Mechanical installation

Method : Cabinet installation

1. Lace the TB4000X chassis on the cabinet bracket as shown in the figure and push it into the cabinet to the installation position. (The cabinet structure in the figure is for reference only)
2. Fix the chassis in the cabinet with nuts through the mounting holes on the mounting ears of the TB4000X chassis.



3.2.3 Electrical installation

Before connecting the power supply, it is recommended to use a multimeter to measure the on-off and short circuit of the cable, confirm the positive and negative poles, and label the cable.

Measuring method:

- **Cable on/off:** select the buzzer of the multimeter, and use the probe to measure the two ends of the same color cable. If the buzzer sounds, it means the cable is available.
- **Short circuit judgment:** select the resistance gear of the multimeter and measure the positive and negative poles at the same end with the probe. If the resistance shows infinite, it means the cable is available.
- **Positive and negative poles:** after the power line is connected visually, the positive and negative poles of the battery shall be respectively connected to the positive and negative poles of the opposite equipment.

Battery parallel connection:

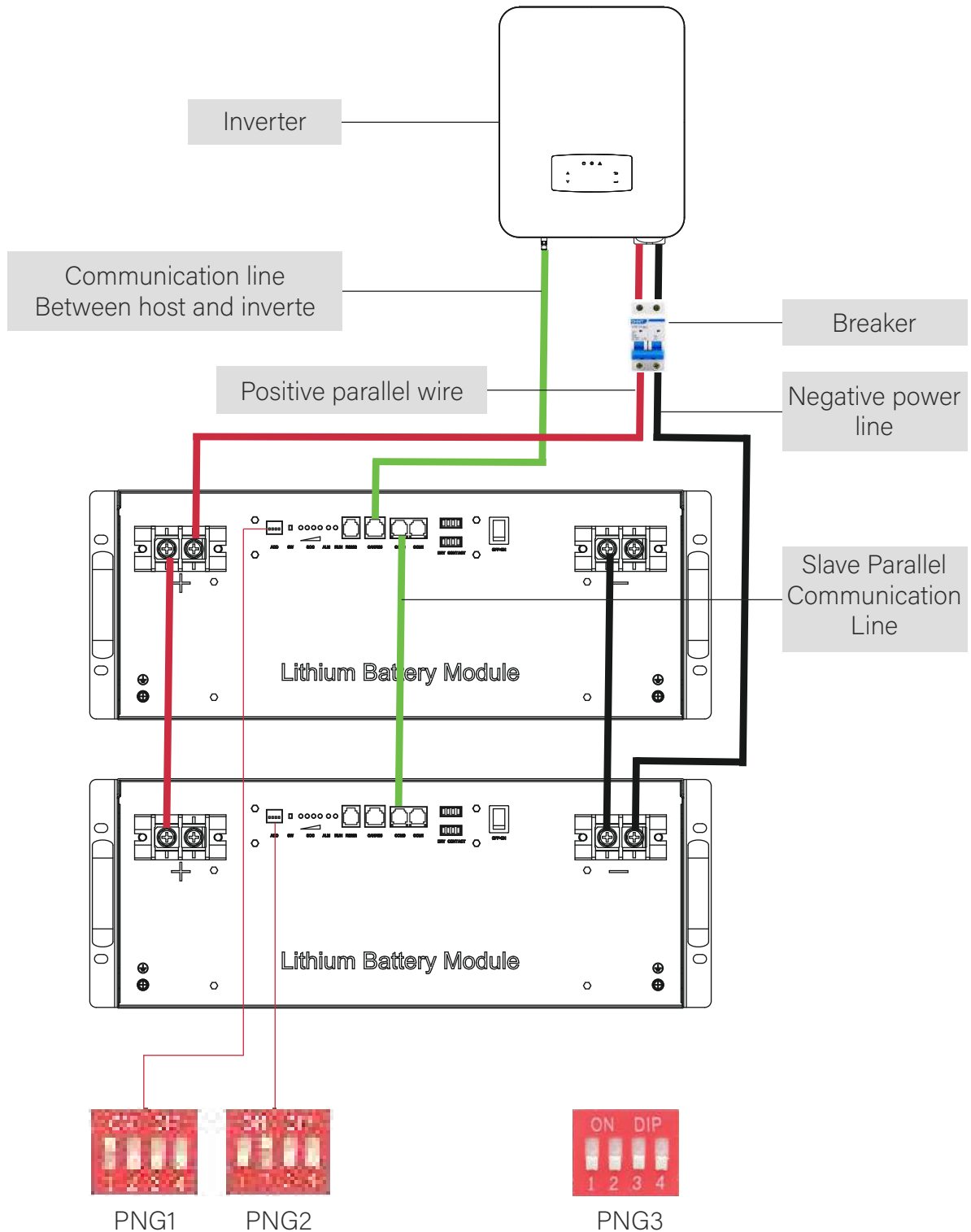

Remark:

1. When the four sets are used in parallel, the dialing mode is as follows: the host dials the code according to the PNG1, the slave1 dials the code according to the PNG2.
2. When it is used independently, the dial switch does not need to be turned, as shown in PNG3.

4. Using, maintenance and troubleshooting

4.1 battery system use and operation instructions

After completing the electrical installation, turn on the battery system as follows:

1. Refer to the description of dial switch in 2.3. 1, make preparations before starting the battery pack, and then press SW key for 3 seconds, run light and SOC light will be on after self inspection.



Pay attention :

After pressing the SW key, if it is found that the battery status indicator on the front panel is on red continuously; please check "4.2 alarm description". If the fault cannot be eliminated, please contact the dealer in time.

1. Use a voltmeter to measure whether the two voltages at the battery access end of the circuit breaker are over 45V, and check whether the voltage polarity is consistent with the inverter input polarity; if the voltage output at the battery access end of the circuit breaker is over 45V, then the battery has started to work normally;
2. After confirming that the output voltage and polarity of the battery are correct, turn on the inverter; turn off the Circuit breaker switch.
3. Check the status of the indicator light (communication indicator light and battery access status indicator light) between the inverter and the battery. if it is normal, the connection between the battery and the inverter is completed. If the indicator light is different Often, please refer to the inverter manual to find out the reason or contact the dealer.

Table 4-1 Battery and inverter power matching table

Hybrid Inverter	Off grid inverter	TA6000 Series	
EPS (Backupport) AC output power	AC output power	Battery Module	Total energy (kWh)
≤ 10 kW		2	10.24
≤ 15 kW		3	15.36
≤ 20 kW		4	20.48

Using requirements	Charge	a. Continuous charging current $\leq 0.5C$ b. If the battery capacity indication is empty, please charge within 48 hours after the power is discharged.
	Discharge	c. Continuous discharging current $\leq 1C$ d. It is recommended that the maximum discharge depth (DOD) of the pack should not exceed 80%

4.2 Alarm Description and Solution

In case of protection action or fault of the system, the alarm signal will be given through the working status indicator light of the front panel, and the specific alarm category can be queried through the network management system. If there are any abnormal faults affecting the output, such as voltage over-voltage, charging over-current, under voltage protection, temperature protection, etc., please handle according to Table 4-2.

Table 4-2 Main alarm and protection

State	Alarm category	Alarm indication	Solution
Charging state	Cell overvoltage	ALM Red light is always on	Stop charging and find out the cause of the fault
	Charge overcurrent	ALM Red light is always on	Stop charging and find out the cause of the fault
	Charging temperature alarm	ALM Red light is always on	Stop charging
Discharging state	Discharge overcurrent alarm	ALM Red light is always on	Stop discharging and find out the cause of the fault
	Discharging temperature alarm	ALM Red light is always on	Stop discharging
	Total voltage undervoltage alarm	ALM Red light is always on	Charge
	Cell Voltage Under-voltage alarm	ALM Red light is always on	Charge

4.3 Analysis and solution of common faults

Common faults and solutions are shown in table 4-3:

Table 4-3 Common faults and solutions

No.	Fault	Causal analysis	Solutions
1	No response of indicator light after power on	Power switch is broken	Power switch
2	No DC output red light on	Battery data status is abnormal	Network management connect with background reading battery information
3	DC power supply time is too short	Reduced battery capacity	Replace a battery
4	Battery cannot be fully charged	Charging voltage is too low	Adjust charging voltage to 54V
5	The power cord port sparked at the moment of power on, and the red light was on	Short circuit in power supply wiring	Turn off the battery, check the cause of the short circuit and solve it

In case of special technical difficulties or questions, please contact the seller in time.

SHENZHEN LITHTECH ENERGY CO., LTD

14th Floor, Block D, Central Avenue, Xixiang Streer, Bao' An District Shenzhen

Code: 518101

E-mail: info@ lith- tec. com

Website: http://www. ltc-energy. com/